

MHP FASTENERS w/ SST CENTERING BARS @ 12" O.C. MAX
 OPTIONAL REPLACEABLE VAPOR BARRIER
 3/8" ALUM. COVER PLATE, MILL FINISH
 CONT. ALUM EXTRUSION, MILL FINISH
 3/8" DROP-IN ANCHORS @ 12" O.C. STAGGERED, BY INSTALLER

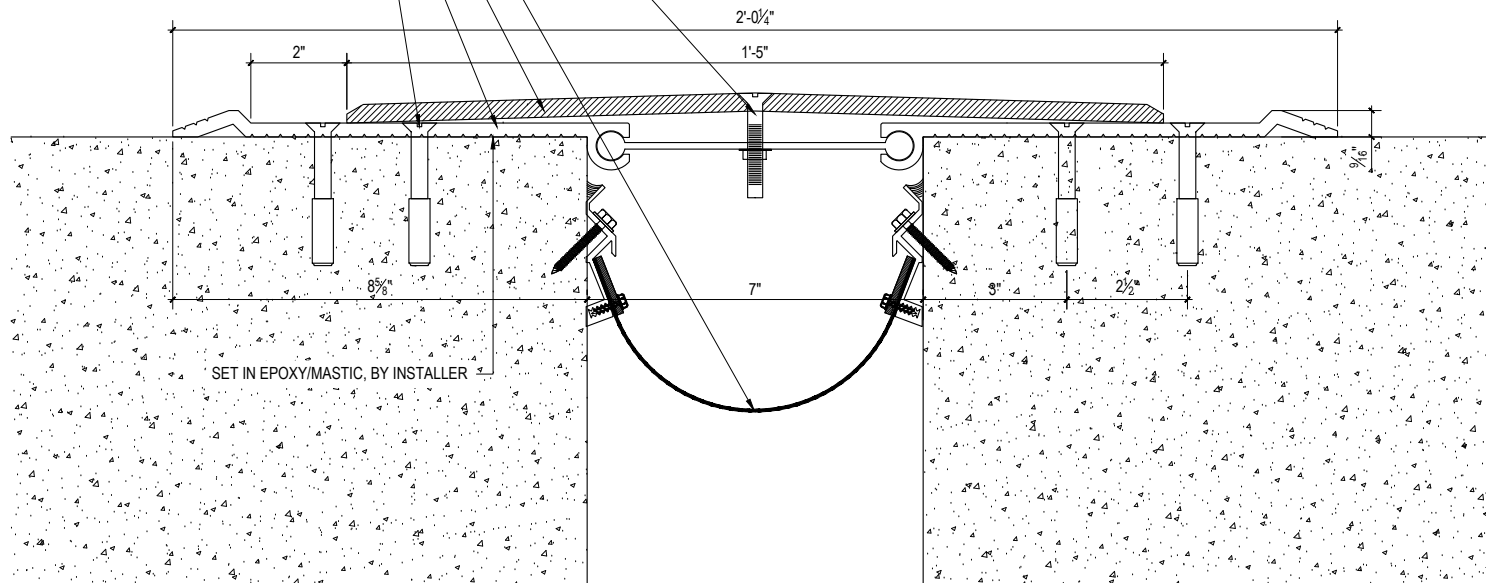
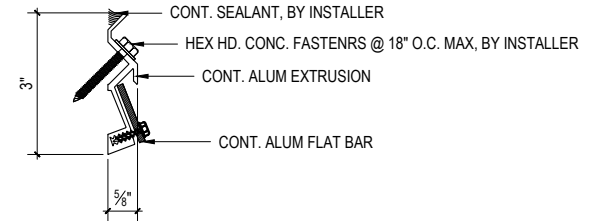

M.H. POWELL & CO., INC.
 ARCHITECTURAL SEISMIC EXPANSION JOINT SYSTEMS

2313 YATES AVENUE | PHONE : (323) 887-0037
 COMMERCE, CA 90040 | FAX : (323) 887-0877
 WEB : www.mhpowell.net

**MODEL
 HD EXW-7**

HD FLOOR TO FLOOR EJC

PROJECT : _____ PROJECT # : _____
 LOCATION : _____ DATE : _____
 ARCHITECT : _____
 CUSTOMER : _____

PAGE #